

StepOneKids

学習塾ステップワン オリジナル教材 幼児向けシリーズ

無料サンプル
ダイジェスト版

分野別くりかえし

積み木の数

この教材は
「分野別くりかえし 積み木の数」シリーズから
一部を抜き出したものです。

[収録教材]

- 問題 1～5 … Step.1
- 問題 6～10 … Step.2
- 問題 11～15 … Step.3

※解答つき



・教材の購入はこちら・

のびラボ!

<http://nobilabo.com>

ステップワン
StepOne

※当教材データの複製、配布、譲渡、転売等を禁じます。
※当教材の記載内容の一切について無断転載や複写、引用等を禁じます。

©2012 Step One All Rights Reserved.

問題 1

つ き かず
積み木の数だけ○をかきましょう。

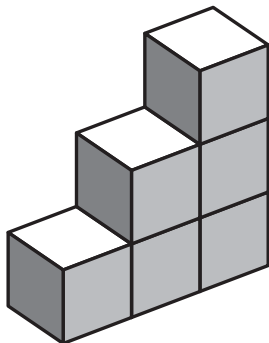
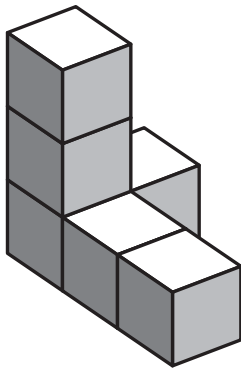
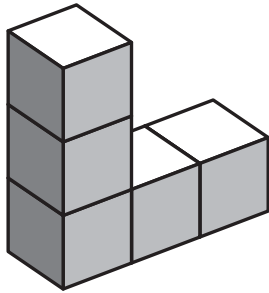
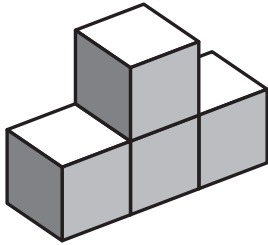

問題 2

みぎ つ き ひだり つ き かず くら おお
右の積み木と左の積み木の数を比べて、多いほうに○をつけましょう。

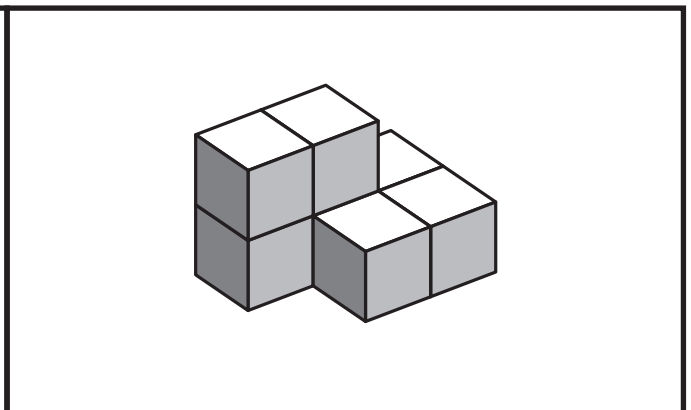
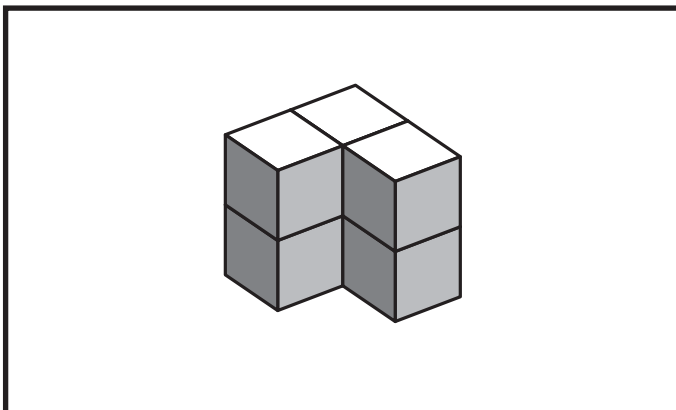
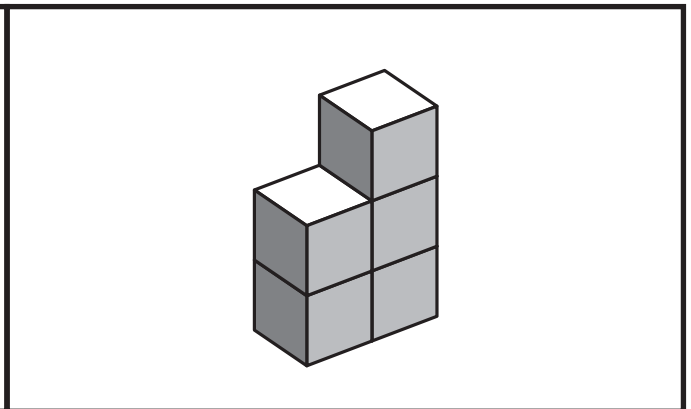
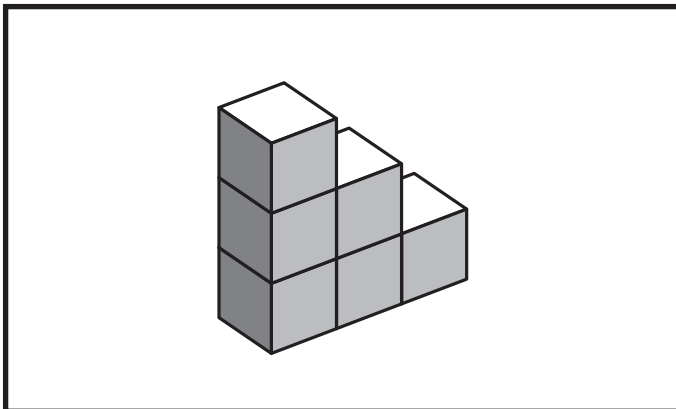
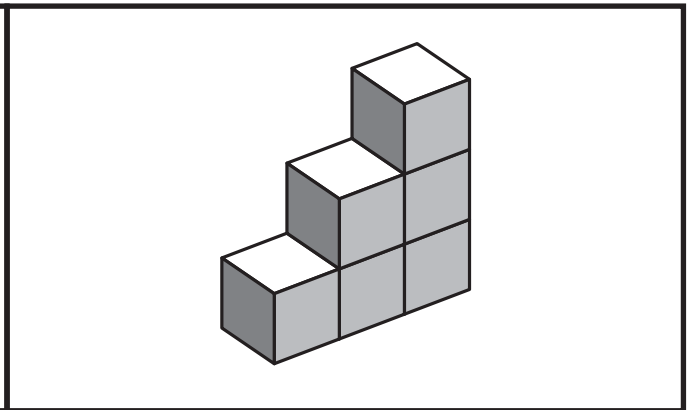
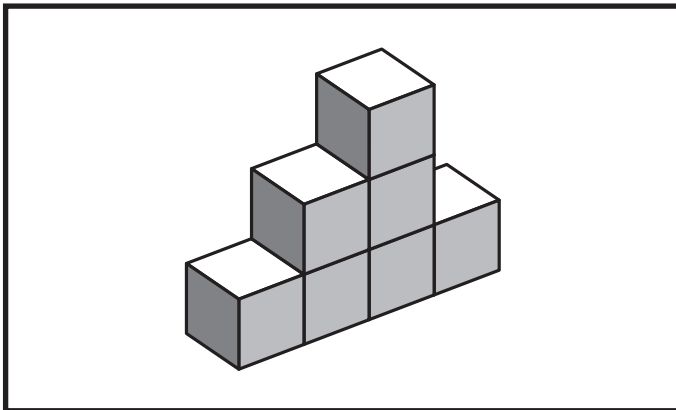
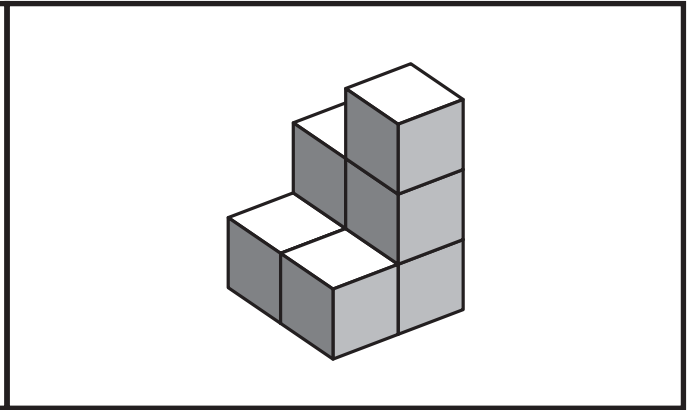
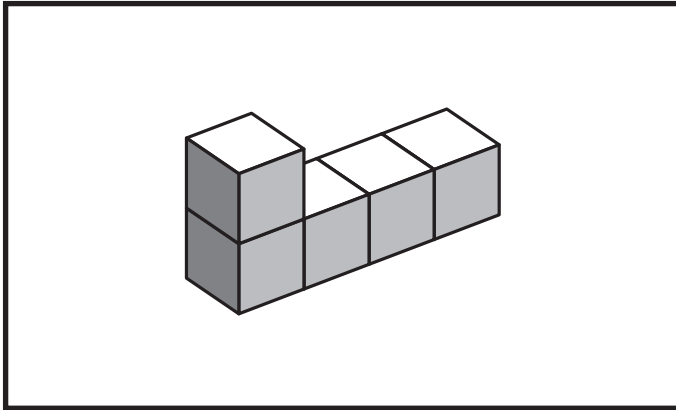

問題 3

ひだり つ き おな かず つ き せん むす
左の積み木と同じ数の積み木を線で結びましょう。

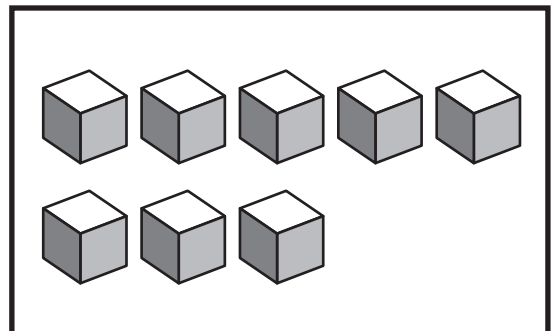
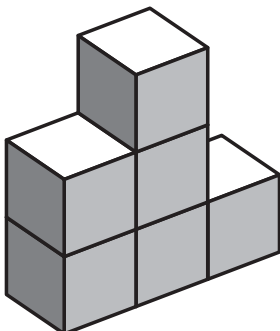
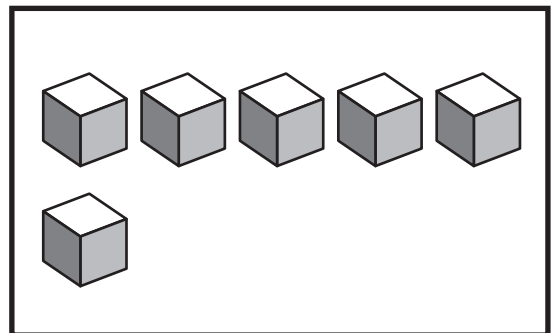
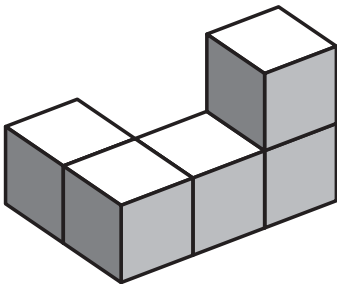
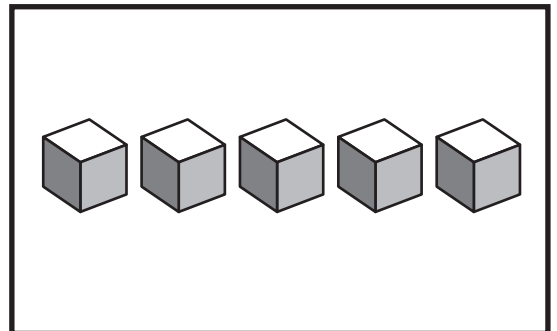
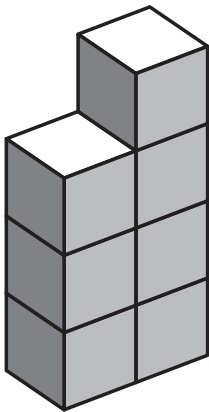
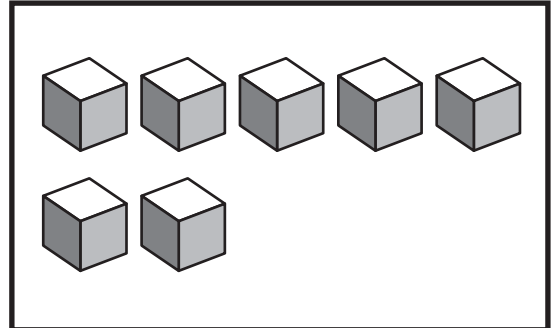
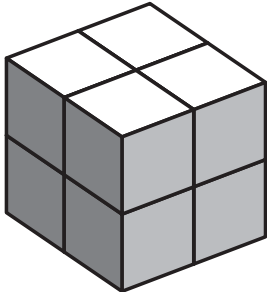

問題 4

ひだり つ き おな かず つ き みぎ
左の積み木と同じ数の積み木は右のうちどれですか。

えら
1つ選んで○をつけましょう。

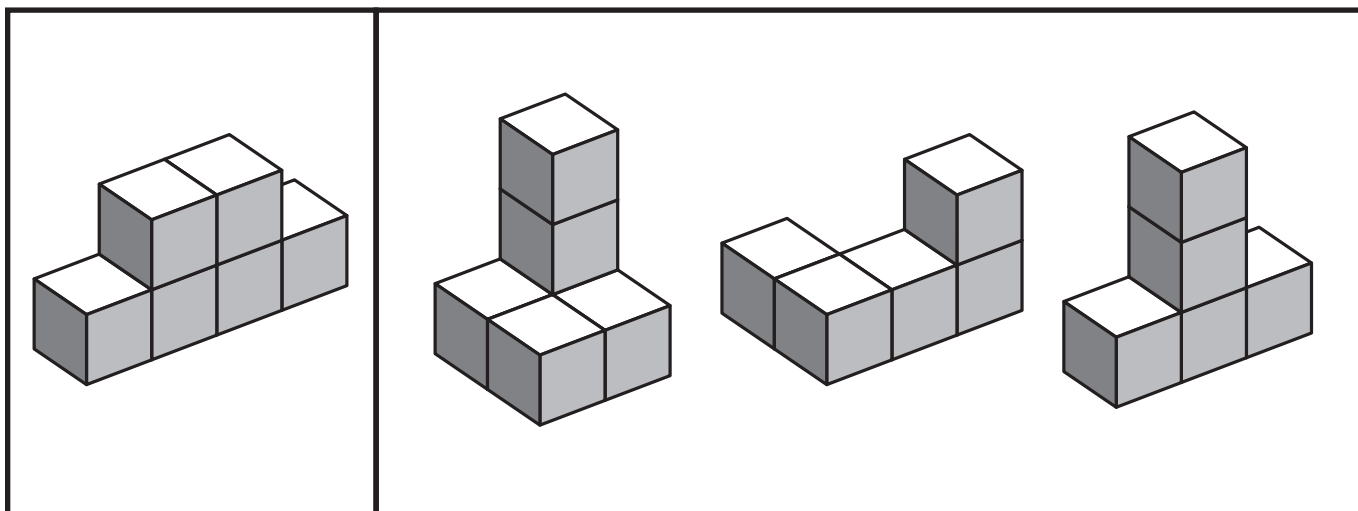
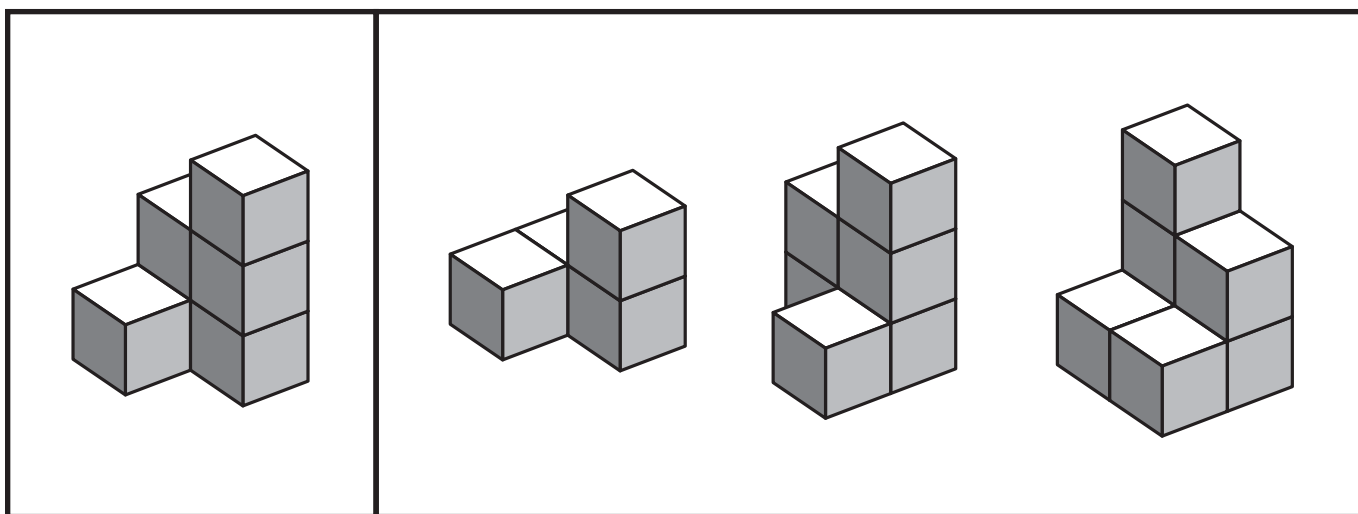
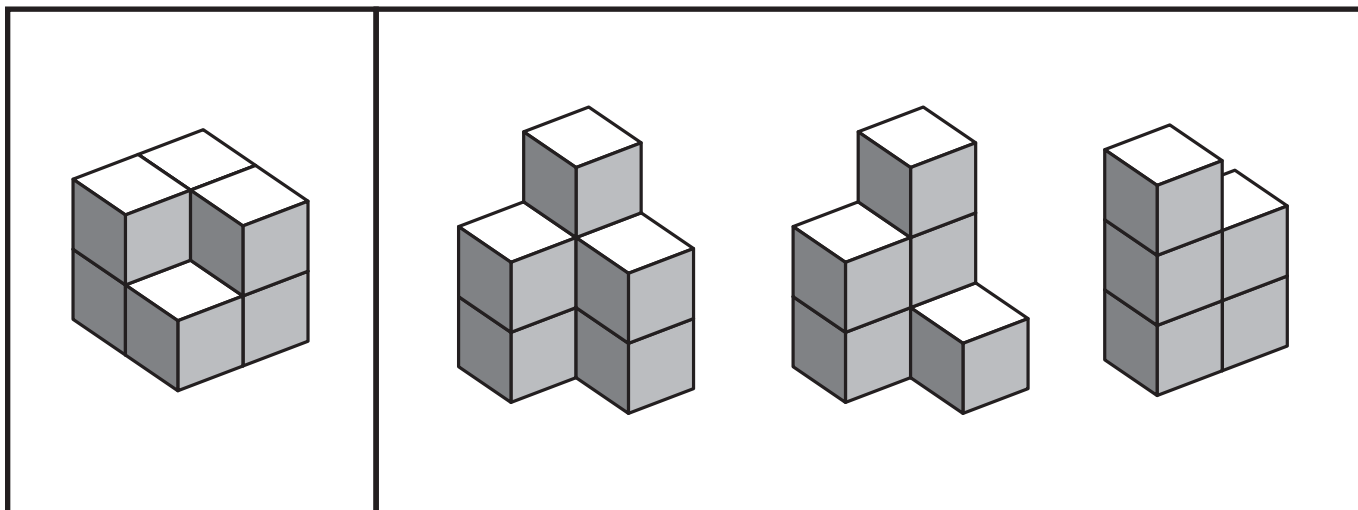

問題 5

みぎ ひだり くら かず すく
右と左を比べて、数の少ないほうに○をつけましょう。

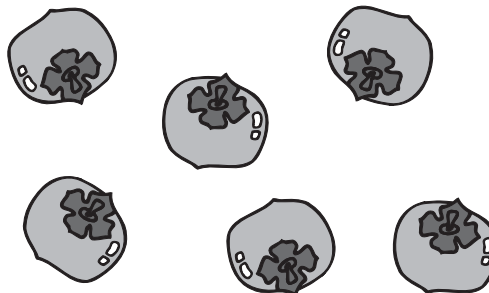
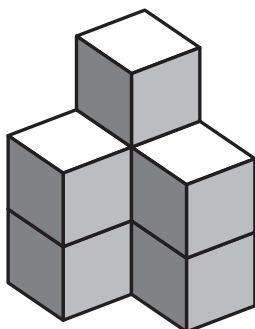
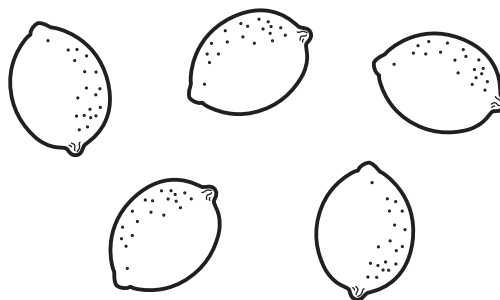
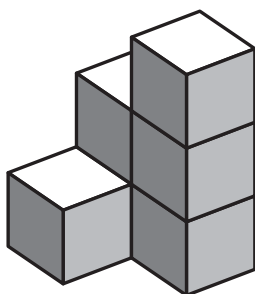
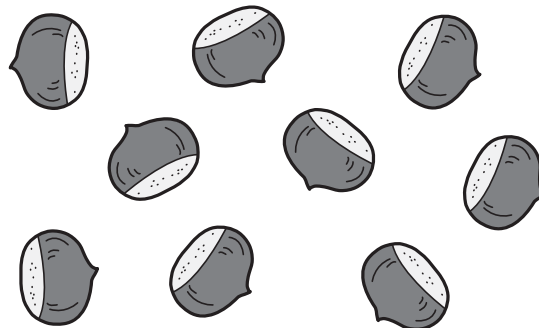
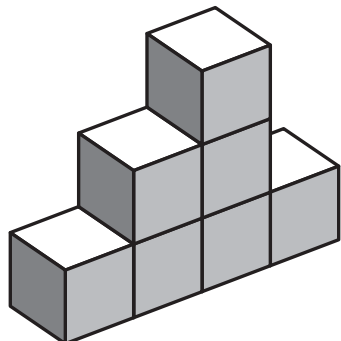

問題 7

みぎ つ き ひだり つ き かず くら おお
右の積み木と左の積み木の数を比べて、多いほうに○をつけましょう。

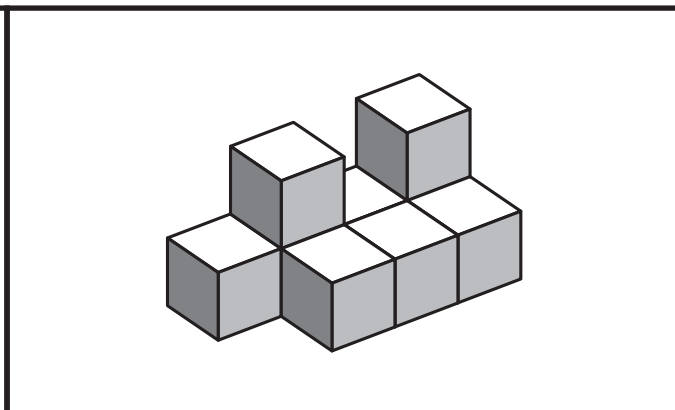
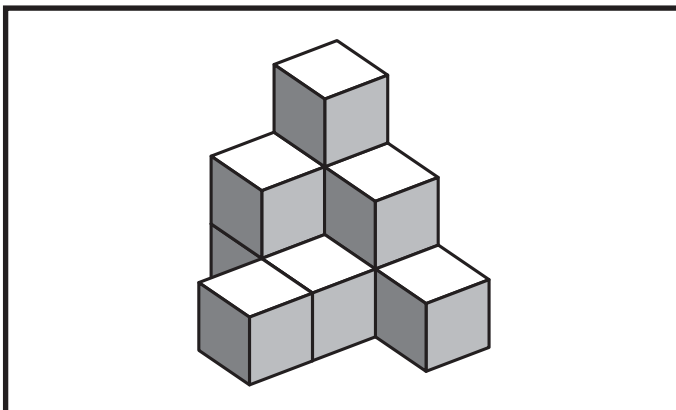
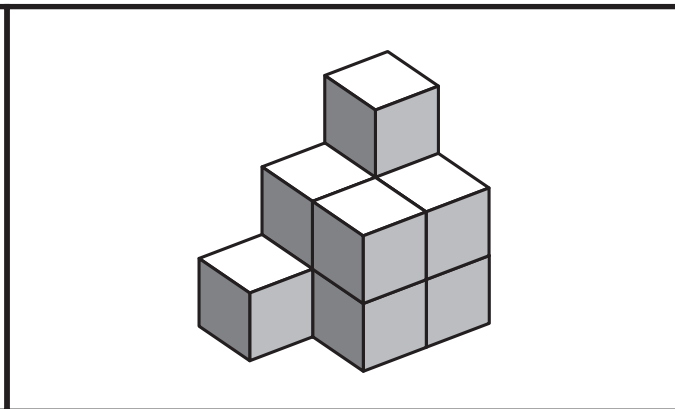
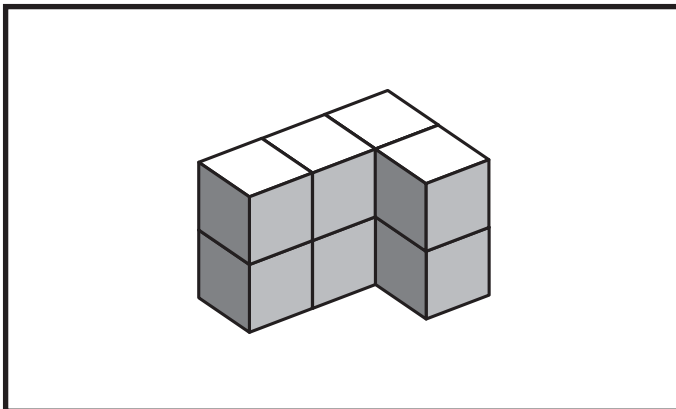
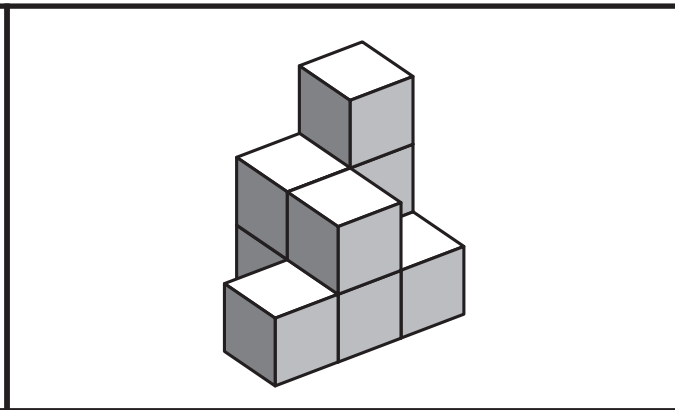
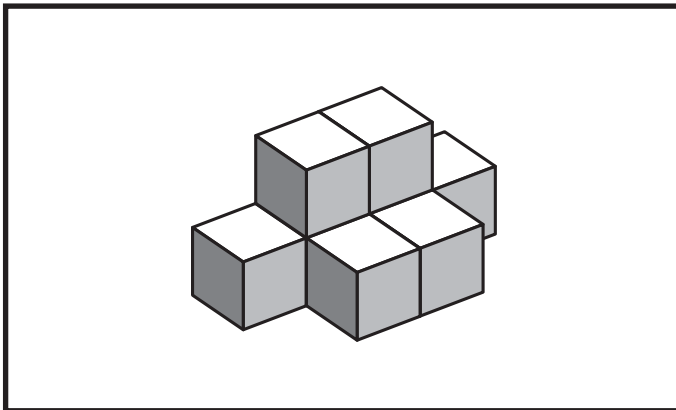
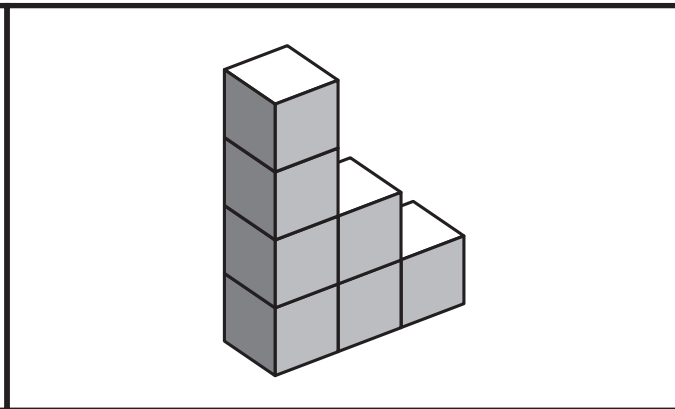
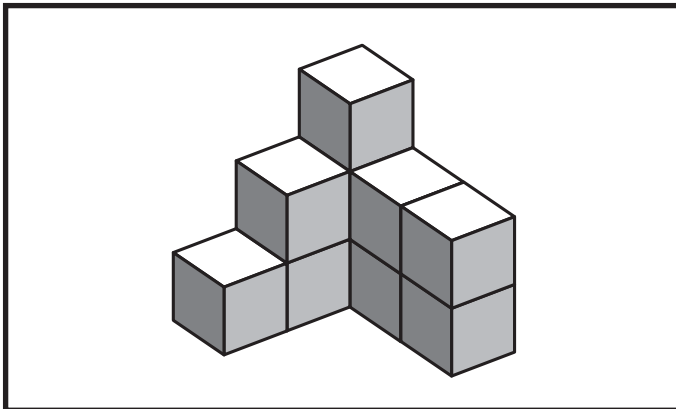

問題 8

ひだり つ き みぎ め おな せん むす
左の積み木と右のサイコロの目が同じになるように線で結びましょう。

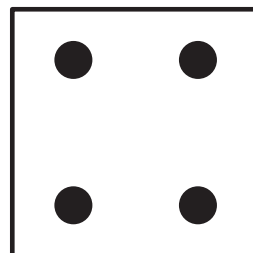
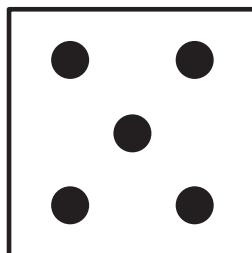
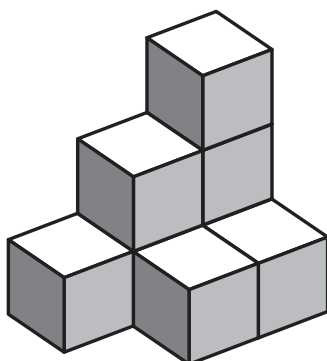
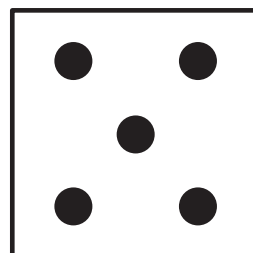
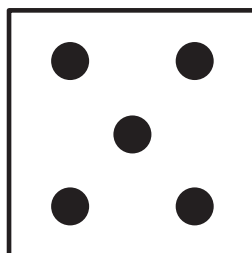
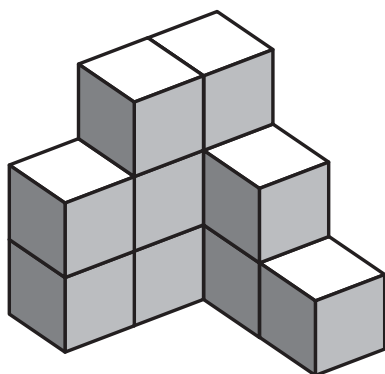
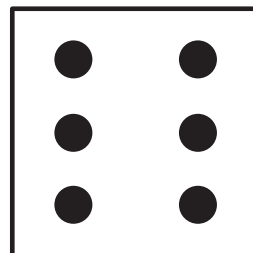
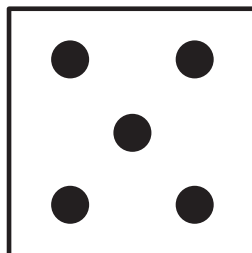
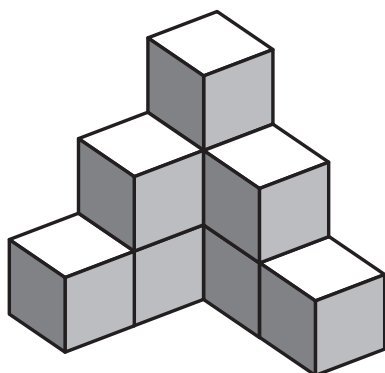
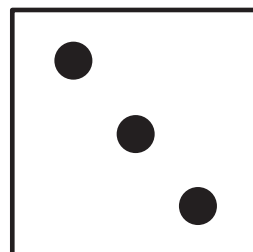
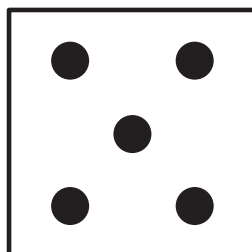
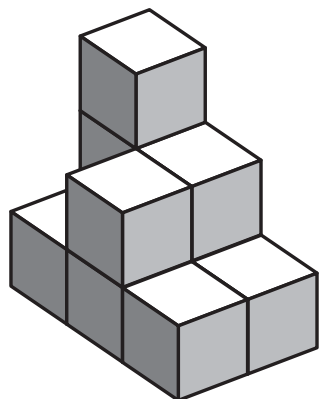

問題 9

みぎ ひだり くら おな かず ちが かず した
右と左を比べて、同じ数ならば○、違う数ならば×を、下の□にかきましょう。

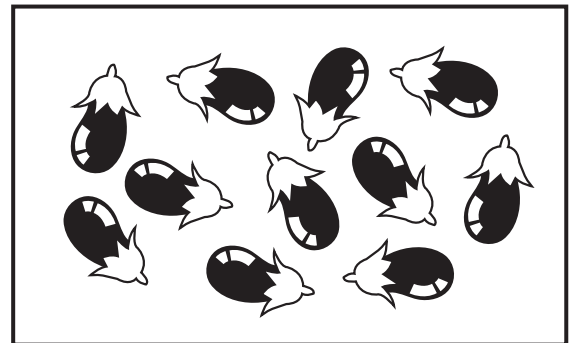
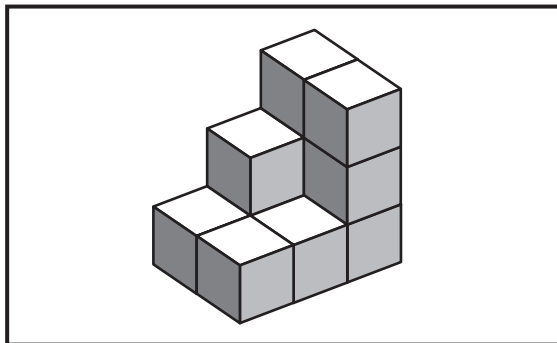
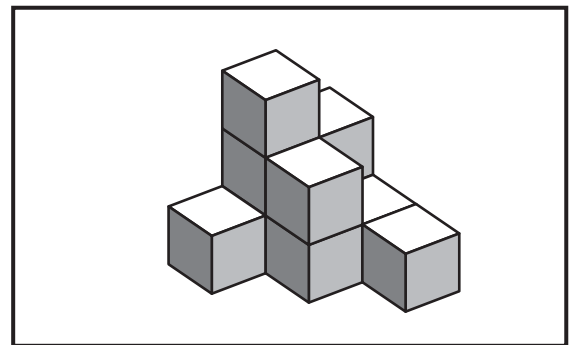
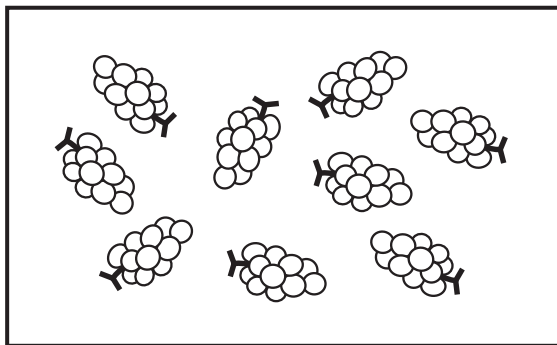
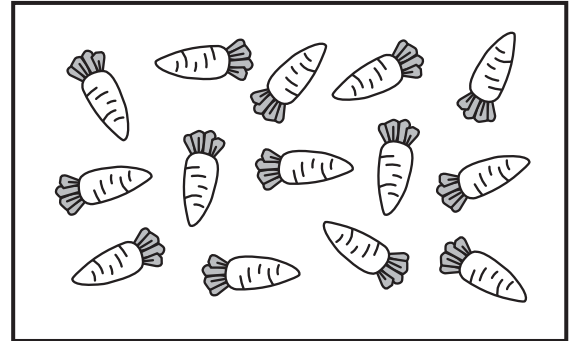
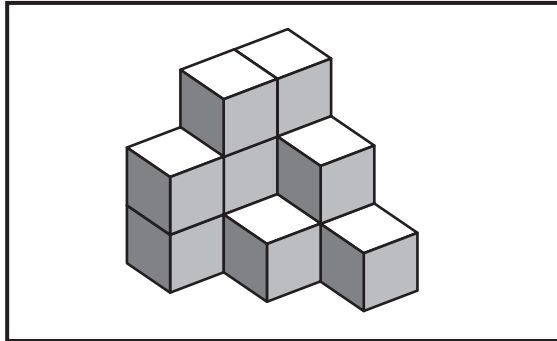

問題 10

ひだり つ き みぎ つ き かたち
左の積み木を右の積み木のような形にするには、あといくつ減らしたら
よいですか。その数だけ右の□の中に○をかきましょう。

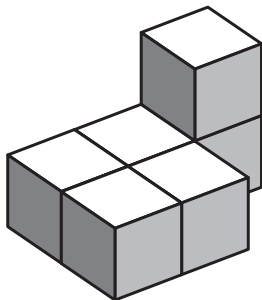
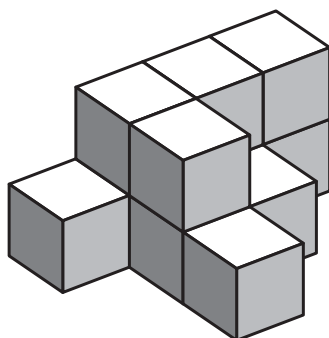
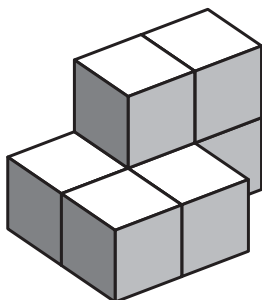
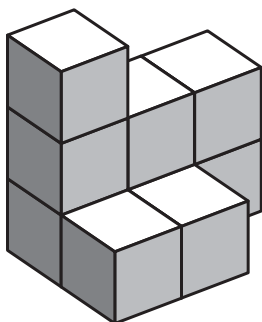
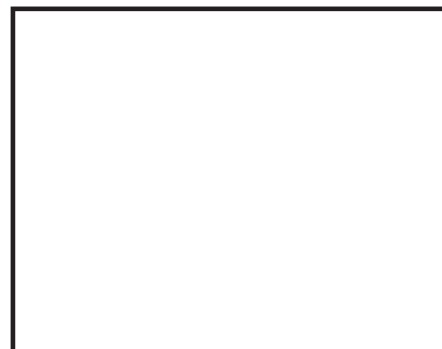
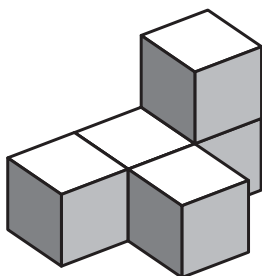
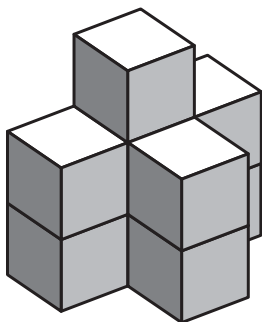
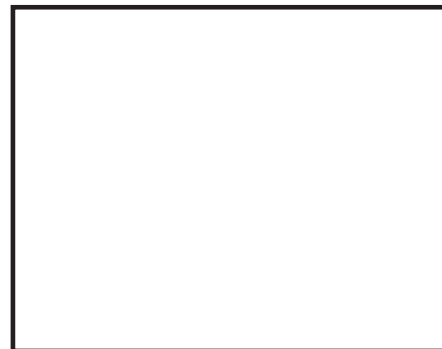
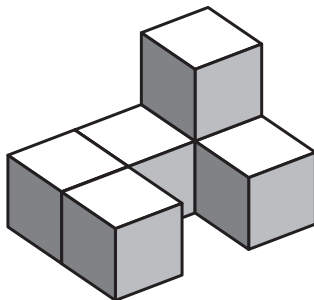
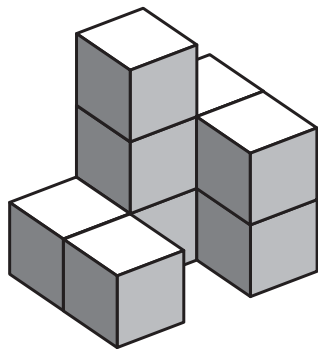

問題 11

つ き かず
積み木の数だけ○をかきましょう。

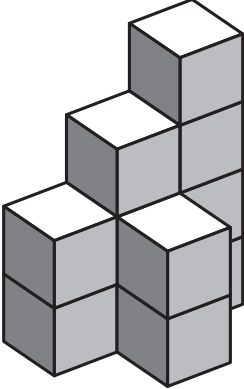
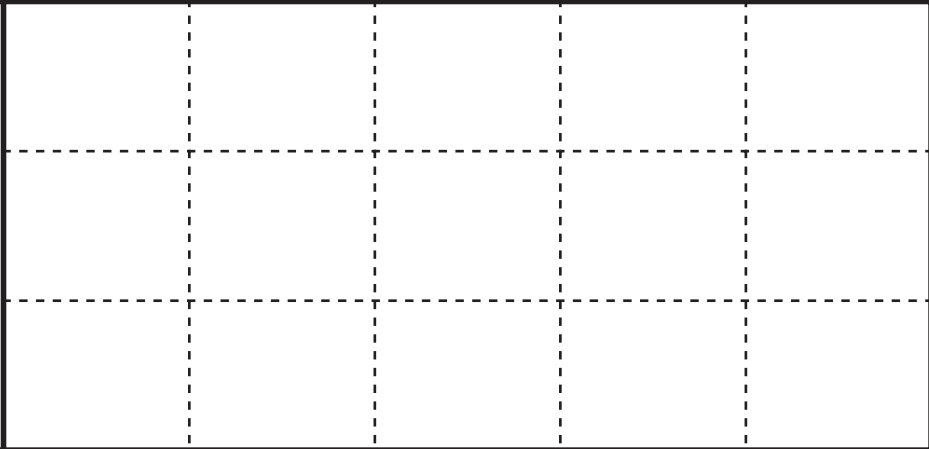
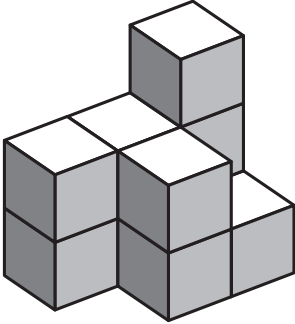
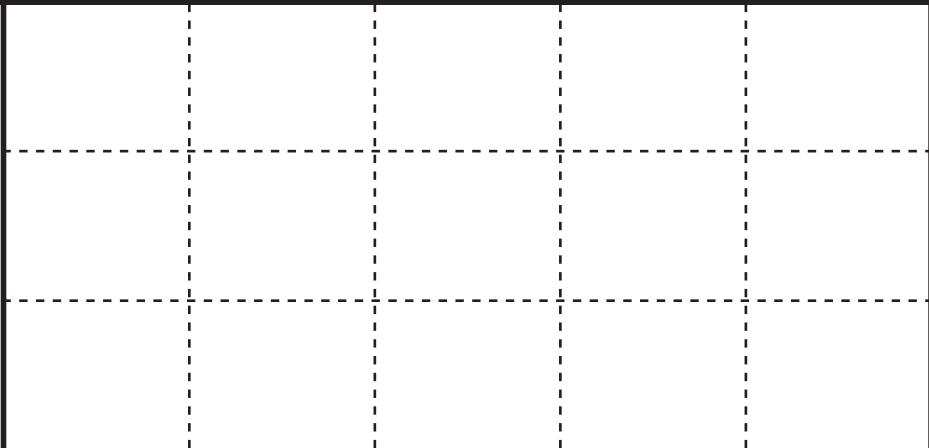
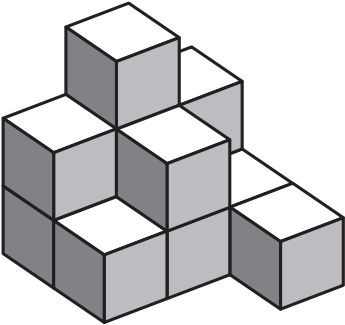
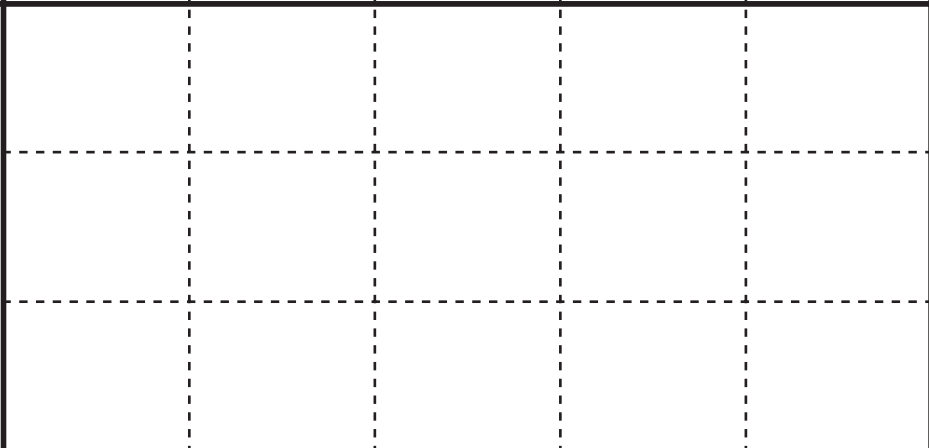
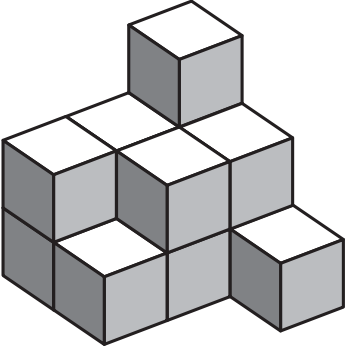
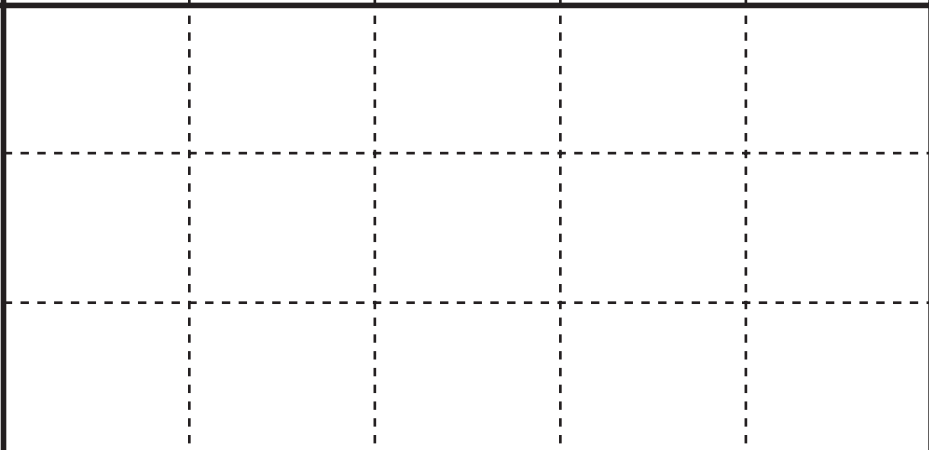
問題 12

ひだり つ き おな かず せん むす
左の積み木と同じ数のちょうちょを線で結びましょう。

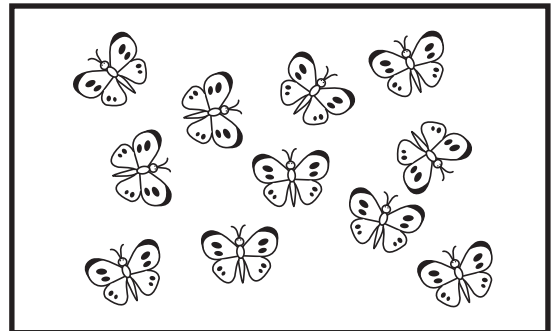
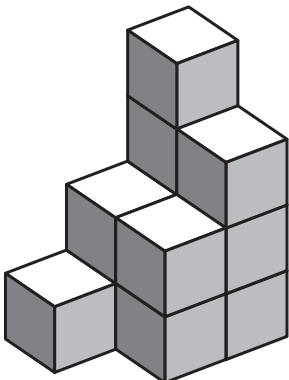
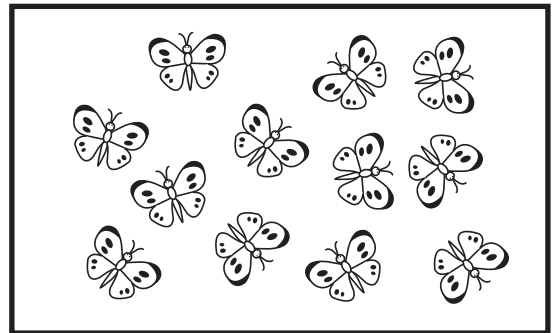
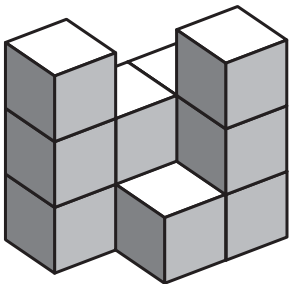
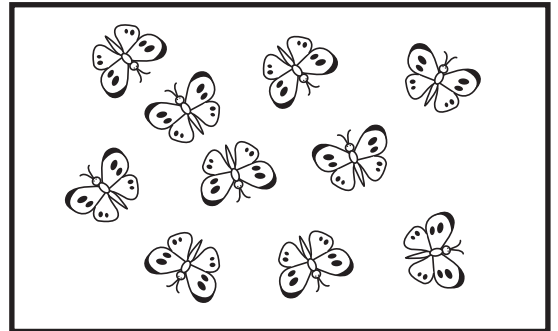
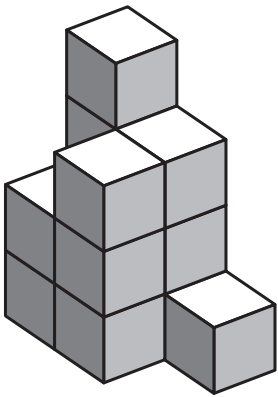
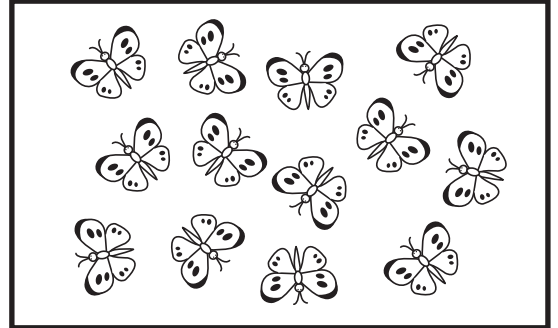
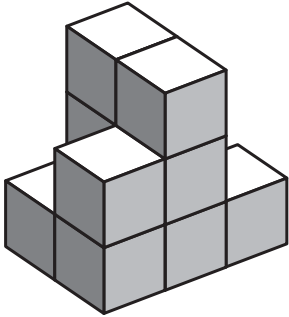

問題 13

いちばんうえ つ き かず おな せん むす
一番上の積み木の数と同じになるように線で結びましょう。

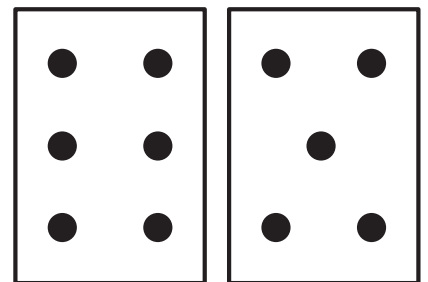
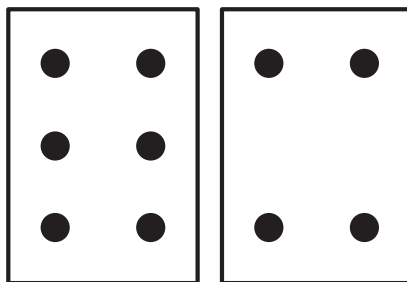
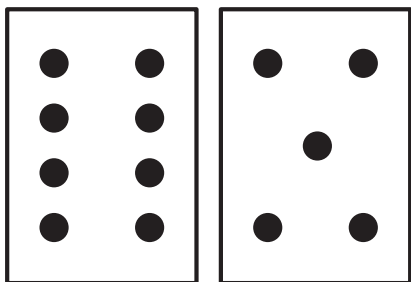
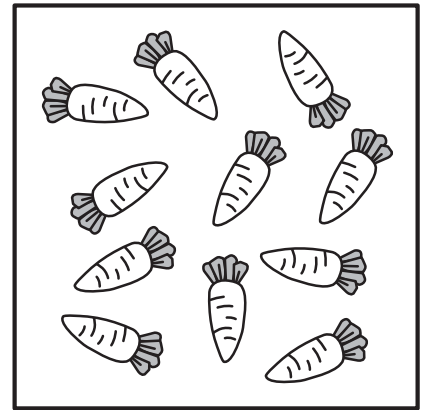
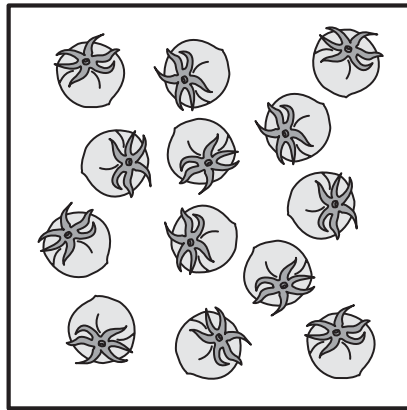
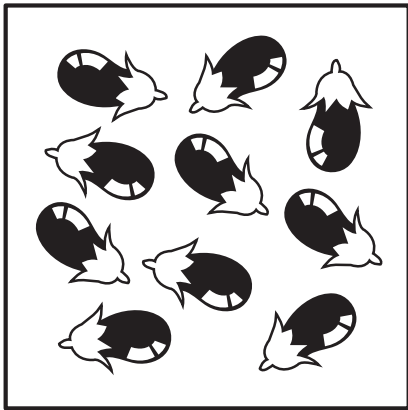
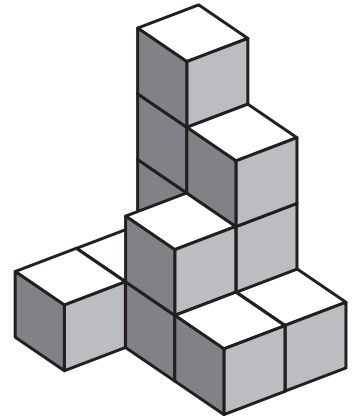
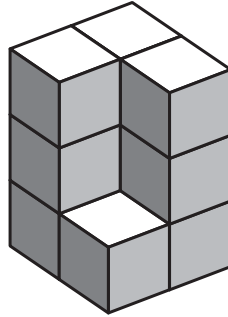
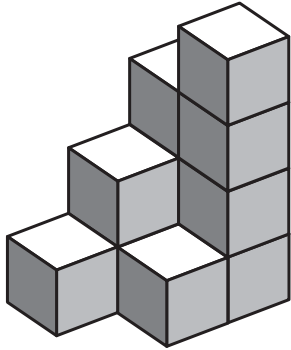

問題 14

積み木の数が一番多いものに×を、2番目に少ないものに◎をつけましょう。

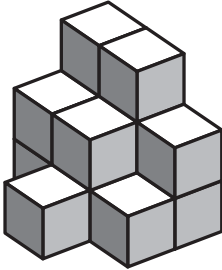
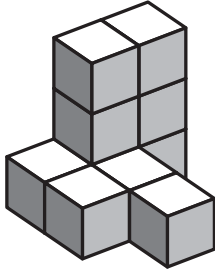
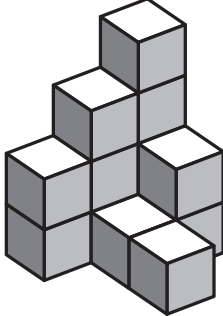
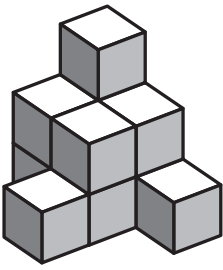
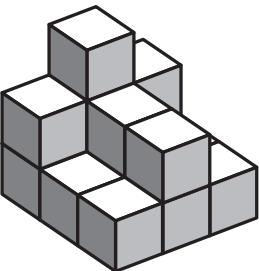
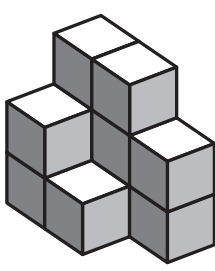
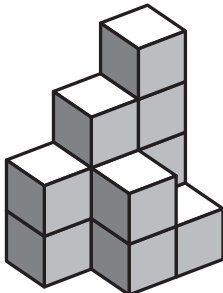
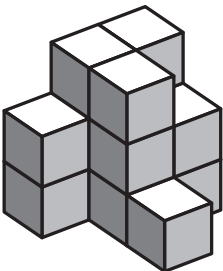
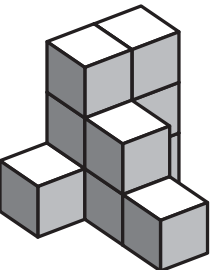
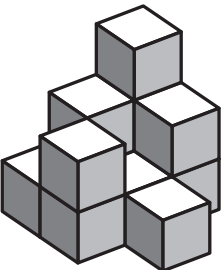
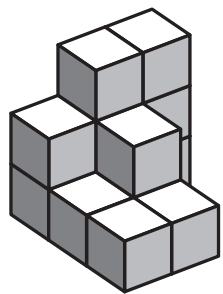
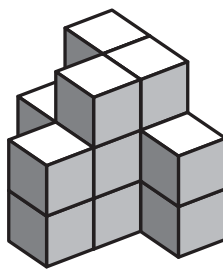
問題 15

ひだり つ き あ ぜんぶ
左の積み木を合わせると、全部でいくつになりますか。

みぎ め くら ぶぶん かず おな えら
右のマス目のうち、黒い部分の数が同じものを選んで○をつけましょう。

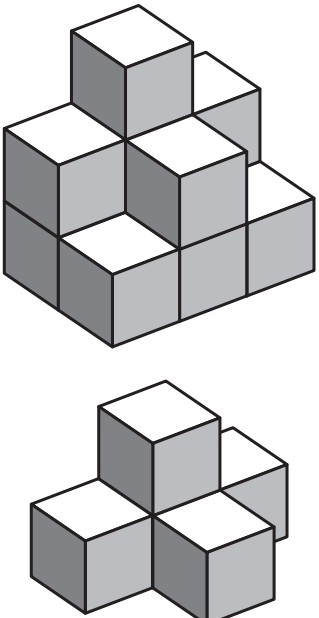

■	■	■	■	■
■	■	■	■	■
■	■	■	■	■
■	■	■	□	□

■	■	■	■	■
■	■	■	■	■
■	■	■	■	■
■	□	□	□	□

■	■	■	■	■
■	■	■	■	■
■	■	■	■	■
■	□	□	□	□

■	■	■	■	■
■	■	■	■	■
■	■	■	■	■
□	□	□	□	□

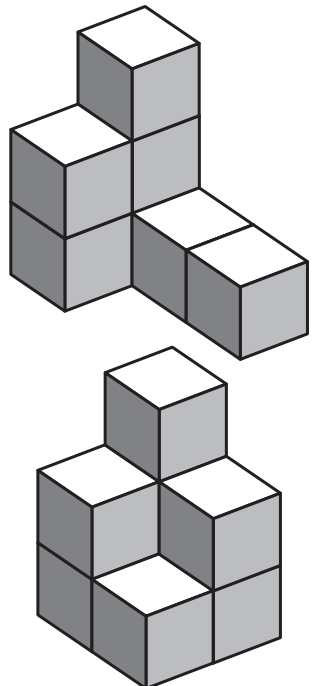

■	■	■	■	■
■	■	■	■	■
■	■	■	■	■
■	■	□	□	□

■	■	■	■	■
■	■	■	■	■
■	■	■	■	■
■	□	□	□	□

■	■	■	■	■
■	■	■	■	■
■	■	■	■	■
□	□	□	□	□

■	■	■	■	■
■	■	■	■	■
■	■	■	■	■
■	■	■	■	□
□	□	□	□	□

<p>問題 1</p>	<p>問題 2</p>	<p>問題 3</p>	<p>問題 4</p>
<p>問題 5</p>	<p>問題 6</p>	<p>問題 7</p>	<p>問題 8</p>
<p>問題 9</p>	<p>問題 10</p>	<p>問題 11</p>	<p>問題 12</p>
<p>問題 13</p>	<p>問題 14</p>	<p>問題 15</p>	